

Abdurrahman_2021_J._Phys._C onf._Ser._1764_012171.pdf

by

Submission date: 02-Nov-2021 12:55AM (UTC-0400)

Submission ID: 1690763843

File name: Abdurrahman_2021_J._Phys._Conf._Ser._1764_012171.pdf (712.46K)

Word count: 1714

Character count: 8789

PAPER • OPEN ACCESS

A Design for Self Balancing Scale Model Bicycle

To cite this article: Umar Tsani Abdurrahman *et al* 2021 *J. Phys.: Conf. Ser.* **1764** 012171

View the [article online](#) for updates and enhancements.

You may also like

- [A discharge estimation model using a spatial correlation method in Cipanunjang-Cibeunca Reservoir, Bandung District, West Java Province](#)
Mariana Marselina and Arwin Sabar

- [Ultrasonic Sensor Application As A Performance Enhancement Of Robot Two Wheels](#)
Yeni Irdayanti, Rd Kusumanto, Masayu Anisah *et al.*

- [Design of two wheel self balancing car](#)
Chun-hong He and Bin Ren



The Electrochemical Society
Advancing solid state & electrochemical science & technology

241st ECS Meeting

May 29 – June 2, 2022 Vancouver • BC • Canada
Abstract submission deadline: Dec 3, 2021

Connect. Engage. Champion. Empower. Accelerate.
We move science forward



Submit your abstract



A Design for Self Balancing Scale Model Bicycle

Umar Tsani Abdurrahman^{1*}, Pria Sukanto¹, Mohamad Anas Sobarnas¹ and Mujiarto²

¹ Department Informatics Engineering, Sekolah Tinggi Teknologi Muhammadiyah Cileungsi, Cileungsi, Bogor, Indonesia 16820

² Department of Mechanical Engineering, Universitas Muhammadiyah Tasikmalaya, Tasikmalaya, Indonesia

*umar.tsani@stm-cileungsi.ac.id

Abstract. This research will describe the development of a self-balancing scale model bicycle. The main reason for just using a scale model instead of a full-size bicycle is to reduce development costs while maintaining the same design principle and software coding. For the hardware we are using a 1:10 metal bicycle model, Arduino Uno board for real-time balance control, GY-521 & MPU 6050 for real-time gyro and 3 axis accelerometers, and servo motor for weight balancing movement. 5-volt Li-ion battery power bank used for a power source. For coding, we use Arduino IDE for windows.

1. Introduction

Bicycle is an old invention, more than 125 years ago. But the whole balancing process of a bicycle was not completely known until recent years. Indeed the mechanism is complicated and includes balancing [1] action from the driver himself along with a couple of other forces acting from the bicycle.

To make modeling and abstraction simple we will reduce the problem onto balancing bicycles based on the inverting pendulum model. This model used with the assumption that bicycles in a rest condition. This is the same condition as an inverting pendulum where the centers of mass is high and cause an instability equilibrium. In the inverting Pendulum, this instability can overcome by moving the lowest part of the pendulum so that the entire mass changes its central mass in dynamic equilibrium.

The self-balancing apparatus today can be made possible by the availability of 3 axis accelerometer sensor chips based on MEMS (Micro Electro Mechanical Systems) [2]. The availability of MEMS sensors improve the quality of both and price / performance, due to Moore's law of microelectronics. The calculations required for this system are relatively low and available. The DC motor implemented in this model can saved from toys. Only power electronics and the pendulum has to be custom-made.

2. Literature Review

One of the successful implementations for a model bike balancing is done by Japanese company Murata named Murata Boy figure 1, a robotic bicycle [3]. With a gyro sensor and a large disc to correct any slant.



Content from this work may be used under the terms of the [Creative Commons Attribution 3.0 licence](https://creativecommons.org/licenses/by/3.0/). Any further distribution of this work must maintain attribution to the author(s) and the title of the work, journal citation and DOI.

Published under licence by IOP Publishing Ltd



Figure 1. Murata Boy, bike and robot as one system [4]

It consists of an accelerometer/gyro sensor under the robot and a reaction wheel pendulum in the middle of the robot (figure 2.).

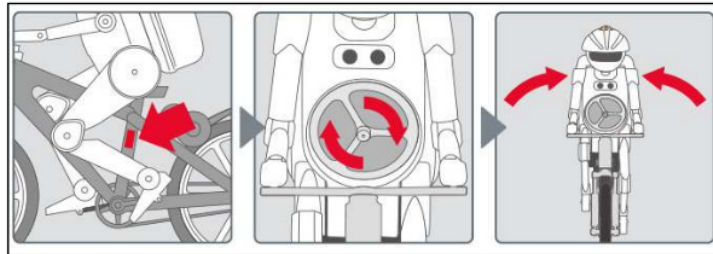

Figure 2. Sensor (left) and reaction wheel pendulum to balance the bike [5]

3. Modeling

Although bicycle stability is complicated, for zero velocity [6] this stability can be achieved by only use an inverting pendulum principle as a figure.3, we only use one axis x here for consideration.

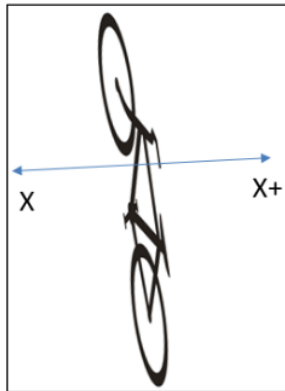

Figure 3. Simplified zero speed bike balancing model

Since the most unstable condition of a bike is at velocity 0, this would tackle the biggest and foremost factor of bike balancing problem, and the dynamic can be simplified as the figure 4.

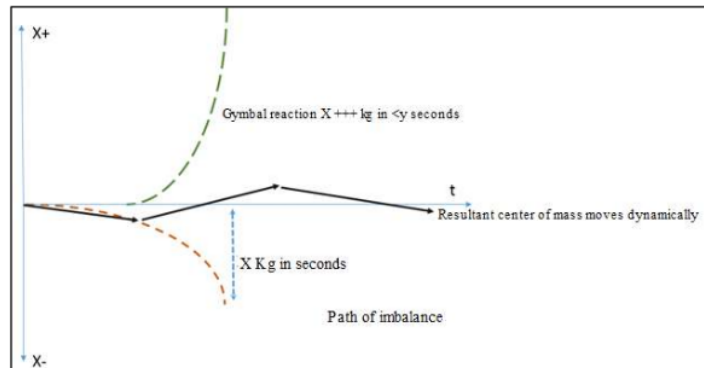
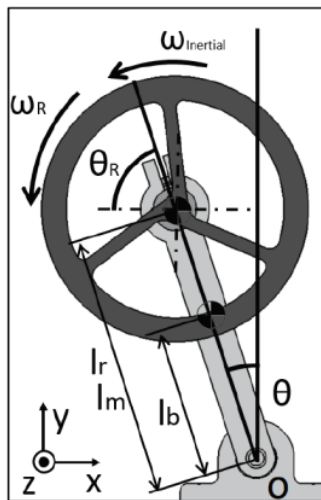

Figure 4. Dynamics of x-axis balancing stability process [7]

Dynamic balancing can be provided through actions on the reaction wheel. The reaction wheel [8] itself is modeled over an inverted pendulum [9] where it has no inherent stability, this stability is provided via a dynamic process of adjusting reaction wheel inertia as in Figure 5 [8].



- M_m : Motor Mass
- M_R : Reaction Wheel Mass
- M_b : Pendulum Arm Mass
- b_b : Pendulum Arm axis viscous friction
- l_b : Pendulum Arm center of mass distance to the axis
- l_m : Motor center of mass distance to the axis
- l_r : Reaction wheel center of mass distance to the axis
- g : Gravitational acceleration.
- τ_c : Effective Motor Control torque
- Inertia:
- I_{bo} : Pendulum concerning point o.
- I_{ro} : Reaction concerning respect to point o.
- I_{mo} : Motor with respecting to point o.
- I_r : Reaction wheel concerning its center of mass.
- Angular Speed:
- ω_R : Wheel speed concerning the pendulum arm
- $\omega_{inertial}$: Wheel Inertial speed.

Figure 5. Reaction wheel model.

One factor that we need to consider is how high is the position of the axis of the reaction wheel from the base (l_m), this actually can have a direct effect on the maximum recovery angle (θ) as can be seen in figure 6.

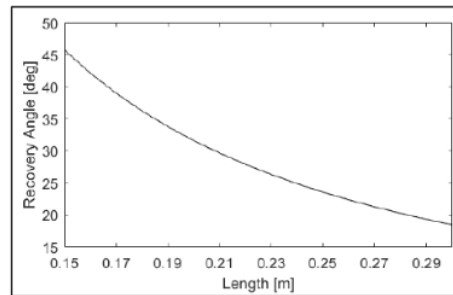

Figure 6. Fix moment of inertia effect to recovery angle vs length of the inverted pendulum

4. Discussion

The parameters are as below:

- M bike = 400 gr M motor = 110 gr - M pendulum = 95gr M electronics = 50gr
- M batt = 100gr so the total: M Total =705gr

The motor torque and specs are as below:

- Standard 130 Type DC Motor - Operating Voltage: 4.5 to 9 V.
- Recommended or Rated Voltage: 6V
- Current at No Load: 70 mA (max) - No-Load Speed: 900 rpm.
- Loaded current: 250 mA (approx) - Rated Load: 10g*cm
- Motor Size: 27.5 mm x 20 mm x 15 mm

The electronics is are using Arduino Uno, IBT2 H Bridge, MPY 6050 Sensors with the diagram as below in figure 7.

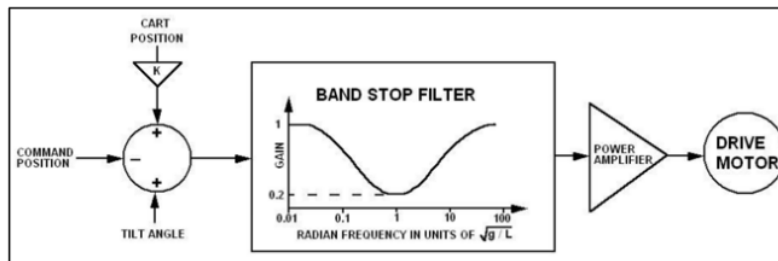
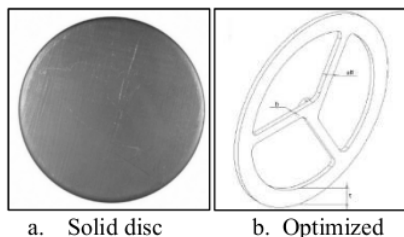

Figure 7. Electronic flow from sensing position to controlling the motor [10]

The reaction wheel pendulum has a diameter of 5 cm, was a solid disc at first (figure 8a), but according to the following equation, the ring is doubling the inertia at the same mass:

So the spoke which connects axis to the outer ring has to be made as thin as possible just enough to make the wheel rigid as in figure 8b. The radius on the equation is the average radius /center mass of the ring.



a. Solid disc b. Optimized

Figure 8. Reaction wheel solid vs optimized (minimum mass, max inertia) [11].

The H-bridge to drive the motor is L298N or MP6513 as a diagram in figure 9.

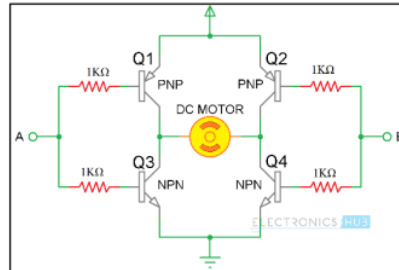

Figure 9. H Bridge to drive the DC motor [12]

The code for constant monitoring of the sensor and adjusting the motor is provided at a high level as in Figure 10.

```
bicycle_balancing_01 | Arduino 1.8.7
File Edit Sketch Tools Help
bicycle_balancing_01 $
// Algorithm: sense accelerometer, send pulse to motor DC/stepper RC or LC
#define STEPPER_PIN_1 9
#define STEPPER_PIN_2 10
#define STEPPER_PIN_3 11
#define STEPPER_PIN_4 12
int step_number = 0;

// (c) UTA 2020
#include "Wire.h" // This library allows you to communicate with I2C devices.
const int MPU_ADDR = 0x68; // I2C address of the MPU-6050. If AD0 pin is set to HIGH, the I2C address will be 0x69.
int16_t accelerometer_x, accelerometer_y, accelerometer_z; // variables for accelerometer raw data
int16_t gyro_x, gyro_y, gyro_z; // variables for gyro raw data
int16_t temperature; // not use
char tmp_str[7]; // temporary variable used in convert function
char* convert_int16_to_str(int16_t i) { // converts int16 to string. Moreover, resulting strings will have the same
  sprintf(tmp_str, "%d", i);
  return tmp_str;
}

void setup() {
  pinMode(STEPPER_PIN_1, OUTPUT);
  pinMode(STEPPER_PIN_2, OUTPUT);
  pinMode(STEPPER_PIN_3, OUTPUT);
  pinMode(STEPPER_PIN_4, OUTPUT);

  Serial.begin(9600);
  Wire.begin();
  Wire.beginTransmission(MPU_ADDR); // Begins a transmission to the I2C slave (GY-521 board)
  Wire.write(0x6B); // PWR_MGMT_1 register
  Wire.write(0); // set to zero (wakes up the MPU-6050)
  Wire.endTransmission(true);
  readsensordbg();
}
}
```

Figure 10. The Algorithm and high-level code on Arduino IDE

5. Conclusion

The design has been made for scale model bicycles however this design can be implemented also for a real bike or motorcycle was given a change in the DC motor with sufficient power and torque, sufficient inertia by bigger pendulum wheel and sufficient power from bigger H bridge power electronic. The inverted pendulum is sufficient to provide a self-balancing for scale model bicycle. However for a full-scale implementation a study has to be made if the design to be implemented with a human passenger

to provide sufficient data on how to provide more stabilization from other dynamic balancing factors such as steering wheel, velocity, gyro effect from the wheels, etc.

References

- [1] J. P. Meijaard, J. M. Papadopoulos, A. Ruina, and A. L. Schwab, "Linearized dynamics equations for the balance and steer of a bicycle: A benchmark and review," *Proc. R. Soc. A Math. Phys. Eng. Sci.*, vol. 463, no. 2084, pp. 1955–1982, 2007.
- [2] K. Dussarlapudi, K. N. Raju, M. Preeti, and A. Sastry, "Genesis of MEMS Accelerometers for Select the Optimal Accelerometer for Bio Applications," *Int. J. Innov. Technol. Explore. Eng.*, vol. 9, no. 2, pp. 4962–4970, 2019.
- [3] J. D. G. Kooijman, A. L. Schwab, and J. P. Meijaard, "Experimental validation of a model of an uncontrolled bicycle," *Multibody Syst. Dyn.*, vol. 19, no. 1–2, pp. 115–132, 2008.
- [4] Murata, "Murata Boy," p. 2020, 2009.
- [5] M. Boy, "MURATA BOY ' s Capabilities," pp. 1–2, 2020.
- [6] G. Mohanarajah, "The Cubli: a cube that can jump up, balance, and 'walk,'" pp. 3722–3727, 2013.
- [7] J. R. Chagdes, S. Rietdyk, M. H. Jeffrey, N. Z. Howard, and A. Raman, "Dynamic Stability of a human standing on a balance board," *J. Biomech.*, vol. 46, no. 15, pp. 2593–2602, 2013.
- [8] G. Belascuen and N. Aguilar, "Design, Modeling and Control of a Reaction Wheel Balanced Inverted Pendulum," *2018 IEEE Bienn. Congr. Argentina, ARGENCON 2018*, pp. 1–9, 2019.
- [9] J. Meyer, N. Delson, and R. A. de Callafon, *Design, Modeling, and Stabilization of a Moment Exchange Based Inverted Pendulum*, vol. 42, no. 10. IFAC, 2009.
- [10] J. C. Gamazo-Real, E. Vázquez-Sánchez, and J. Gómez-Gil, "Position and speed control of brushless dc motors using sensorless techniques and application trends," *Sensors*, vol. 10, no. 7, pp. 6901–6947, 2010.
- [11] M. D. Hasha, "High-Performance Reaction Wheel Optimization for Fine-Pointing Space Platforms : Minimizing Induced Vibration Effects on Jitter Performance plus Lessons Learned from Hubble Space Telescope for Current and Future Spacecraft Applications On-Orbit Satellite," *NASA Tech. Reports*, no. Proceed dings of the 43 rd Aerospace Mechanisms Symposium, NASA Ames Research Center, pp. 373–400, 2016.
- [12] S. Kivrak, H. Power, and G. Systems, "H Bridge DC Motor Driver Design and Implementation with Using dsPIC30f4011," no. May 2017.

ORIGINALITY REPORT

17%

SIMILARITY INDEX

14%

INTERNET SOURCES

12%

PUBLICATIONS

9%

STUDENT PAPERS

MATCH ALL SOURCES (ONLY SELECTED SOURCE PRINTED)

6%

★ Mariana Marselina, Arwin Sabar. "A discharge estimation model using a spatial correlation method in Cipanunjang-Cileunca Reservoir, Bandung District, West Java Province", IOP Conference Series: Earth and Environmental Science, 2021

Publication

Exclude quotes Off

Exclude matches Off

Exclude bibliography On

GRADEMARK REPORT

FINAL GRADE

/0

GENERAL COMMENTS

Instructor

PAGE 1

PAGE 2

PAGE 3

PAGE 4

PAGE 5

PAGE 6

PAGE 7
