

Benkouider_2021_J._Phys._Con f._Ser._1764_012204.pdf

by

Submission date: 02-Nov-2021 12:55AM (UTC-0400)

Submission ID: 1690763891

File name: Benkouider_2021_J._Phys._Conf._Ser._1764_012204.pdf (1.56M)

Word count: 2888

Character count: 14838

PAPER • OPEN ACCESS

Four-scroll chaotic attractor and four-scroll hyperchaotic attractor generated from a new four-dimensional dynamical system

To cite this article: Khaled Benkouider *et al* 2021 *J. Phys.: Conf. Ser.* **1764** 012204

View the [article online](#) for updates and enhancements.

You may also like

- [A New 4-D Hyperchaotic System with Four-Scroll Hidden Attractor, Its Properties and Bifurcation Analysis](#)
L G Dolvis, S Vaidyanathan, K Jacques et al.
- [A new hyperchaotic complex system and its synchronization realization](#)
Zhengfeng Li, Fangfang Zhang, Xue Zhang et al.
- [Modified projective synchronization of a new four-dimensional chaotic system using active control](#)
Y Tang, Q Miao, S Lu et al.



The Electrochemical Society
Advancing solid state & electrochemical science & technology

241st ECS Meeting

May 29 – June 2, 2022 Vancouver • BC • Canada
Abstract submission deadline: Dec 3, 2021

Connect. Engage. Champion. Empower. Accelerate.
We move science forward



Submit your abstract



Four-scroll chaotic attractor and four-scroll hyperchaotic attractor generated from a new four-dimensional dynamical system

Khaled Benkouider^{1*}, Toufik Bouden¹, Mustak E. Yalcin², Aceng Sambas³, Mujiarto³, Muhamad Ali Pahmi⁴, Akhmad Sutoni⁵ and Widjajani⁶

¹Non Destructive Testing Laboratory, Automatic Department, Jijel University, Algeria

²Department of Electronics and Communication Engineering, Istanbul Technical University, Turkey

³Department of Mechanical Engineering, Universitas Muhammadiyah Tasikmalaya, Indonesia

⁴Department of Industrial Engineering, Sekolah Tinggi Teknologi Cileungsi, Indonesia

⁵Department of Industrial Engineering, Universitas Suryakencana, Cianjur, Indonesia

⁶Industrial Engineering Study Program, Universitas Langlangbuana, Bandung, Indonesia

*benkouider.khaled@gmail.com

Abstract. In this paper, a new 4-D hyperchaotic system with one equilibrium point is first introduced. It contains ten terms with three quadratic nonlinearities. Of particular interest is that this novel system can generate periodic attractor, quasi-periodic attractor, four-scroll chaotic attractor and four-scroll hyperchaotic attractor with the variation of one of its parameters. Major dynamical properties of the new system are investigated such as sensitivity to the initial conditions, dissipativity, equilibrium point stability, Kaplan-Yorke dimension, Lyapunov exponents spectrum and bifurcation diagram. In addition, an equivalent electronic circuit schematic is implemented using Multisim software; the obtained results confirm the feasibility of the proposed system.

Keywords: Chaos, hyperchaos, chaotic system, four-scroll attractor, Lyapunov exponent, bifurcation, electronic circuits

1. Introduction

In the past 60 years, research on chaotic systems has a great intention from scientific communities, especially after the famous work of the American meteorologist Edward Lorenz in 1963 [1]. He identified the main property of the chaotic systems, which is the high sensitivity to the initial conditions. A little variation in the initial values of the chaotic system lead to a very different and unpredictable behaviours. The high complex behaviour of this kind of systems make them very useful in many field of sciences such as secure communication [2-5].

The main tool to characterize a chaotic behaviour of a dynamical system is the Lyapunov exponents. More clearly, a Lyapunov exponent is calculated by considering two adjacent initial values of a dynamical system. If this system exhibit a chaotic behaviour, the trajectories generating from those initial values will diverge exponentially, the parameter that characterize the rate of that divergence is a Lyapunov exponent. In fact, for each of the state-space dimensions there is a



Content from this work may be used under the terms of the [Creative Commons Attribution 3.0 licence](https://creativecommons.org/licenses/by/3.0/). Any further distribution of this work must maintain attribution to the author(s) and the title of the work, journal citation and DOI.

Published under licence by IOP Publishing Ltd

corresponding Lyapunov exponent. For a dynamical system that exhibit a chaotic behaviour, at the minimum one of the exponents is positive. If there is more than one positive exponents the dynamics of the corresponding system expand in more than one direction, which means that it exhibit a more complex behaviour and we called it in this case: hyperchaotic system.

One of the most important uses of the chaotic systems is to secure transmissions using different methods and schemes. The complex signals with random appearance that is generated by the chaotic systems are used to hide the secret information to be transmitted. For that reason, many of chaotic systems is introduced in literature [6-10] to meet with the high demand for this kind of complex systems in the fields of secure communication with chaotic encryption. Furthermore, as we said before, the researchers found that compared with the usual low dimensional chaotic systems; the high dimensional ($n > 3$) hyperchaotic systems with more than one positive Lyapunov exponent can generate more complex and random signals with more unpredictability, which enhance the security of the chaotic transmissions. For these reasons, many of 4D hyperchaotic systems with two positive Lyapunov exponents have been constructed [11-15] after the first one of Rossler in 1979 [16].

This work proposes a new 4-D hyperchaotic system with very high degree of disorder. It can exhibit four-scroll hyperchaotic attractor; four scroll chaotic attractor, quasi-periodic and periodic orbits, which make it very complex and very useful for applications that is need complexity.

2. The New 4-D Hyperchaotic System

2.1 Algebraic Structure of The New System

The new system (1) has four parameters, and comprises three nonlinear terms. It is described by the following 4-D autonomous differential equations:

$$\begin{cases} \dot{x} = -ax + y(1+z) \\ \dot{y} = x - ay + bxz \\ \dot{z} = cz - bxy + w \\ \dot{w} = -dz \end{cases} \quad (1)$$

Where x, y, z and w are the state variables and a, b and c are the positive constant parameters, d is the control parameter that belongs to $[0, 1]$. When the parameters values are chosen as:

$$a = 4, b = 0.5, c = 0.6, d = 0.1 \quad (2)$$

System (1) generates a four-scroll hyperchaotic attractor. In Figure 1, we generate the x - y , x - z , y - z and x - y - z attractors of system (1) using the MATLAB ode45 function and starting from the initial point:

$$(x_0, y_0, z_0, w_0) = (1, 1, -1, 1) \quad (3)$$

2.2 Sensitivity to Initial Conditions

As we know, the main property of the chaotic systems is that of the sensitivity to the initial values. The high sensitivity to the initial conditions implies the existence of chaos. Figure 2 shows the different hyperchaotic behaviours exhibited by system (1) for two very near initial values ($\pm 10^{-5}$) that is due to the high sensitivity of the new hyperchaotic system (1) to the initial conditions.

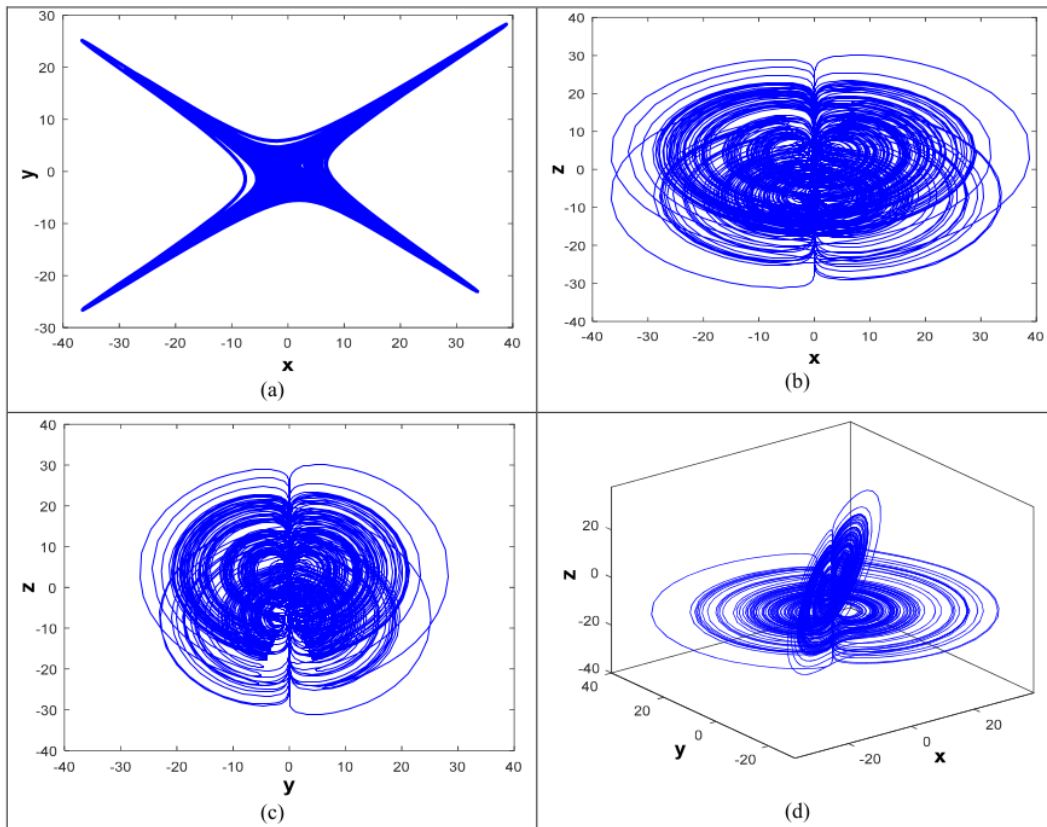

Figure 1 Phase portraits of the four-scroll hyperchaotic attractor generated from system (1). (a) x - y attractor, (b) x - z attractor, (c) y - z attractor, (d) x - y - z attractor.

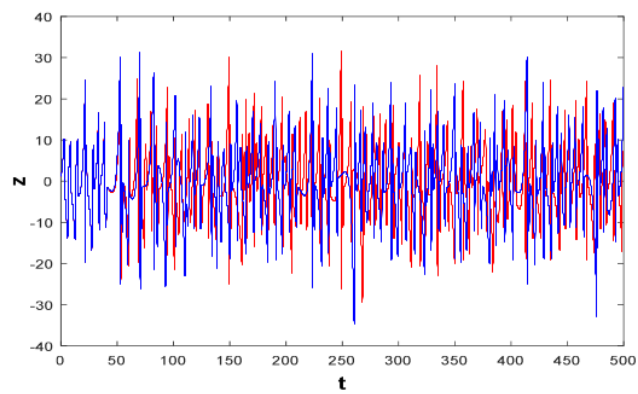

Figure 2 Time series of the z variable for $z_0 = 1$ (blue) and $z_0 = 1.00001$ (red)

2.3 Lyapunov Exponents and Kaplan-Yorke Dimension

The two most important tools to characterize a chaotic behaviour of a system are the Lyapunov exponents and the Kaplan-Yorke dimension. The Lyapunov exponents of the proposed model (1) are shown in Figure 3 as:

$$LE_1 = 0.136, LE_2 = 0.068, LE_3 = 0.000, LE_4 = -7.603 \tag{4}$$

As shown in Figure 3, there are two positive Lyapunov exponents. Hence, the proposed 4-D system (1) is hyperchaotic.

Then, the corresponding Kaplan-Yorke dimension is:

$$D_{KY} = j + \frac{1}{|L_{j+1}|} \sum_{l=1}^j L_l \quad \text{where} \quad \sum_{l=1}^j L_l > 0 \quad \text{and} \quad \sum_{l=1}^{j+1} L_l < 0$$

$$D_{KY} = 3 + \frac{LE_1 + LE_2 + LE_3}{|LE_4|} \tag{5}$$

$$D_{KY} = 3 + \frac{0.204}{|-7.603|} = 3.026$$

Since the Kaplan-Yorke dimension is fractal. So, the new model generates a complex hyperchaotic behaviour.

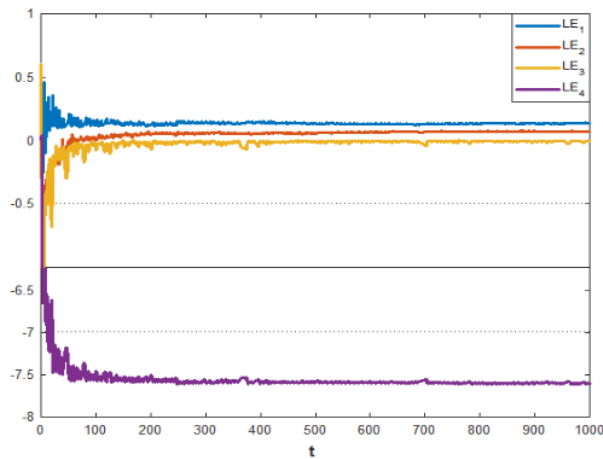

Figure 3 Lyapunov exponents of the new system (1) for the parameters values (2) and the initial conditions (3)

3. Dynamical Analysis of the New Hyperchaotic System

3.1 Dissipativity

The divergence of the system (1) is calculated using the following equation:

$$\nabla V = \frac{\partial \dot{x}}{\partial x} + \frac{\partial \dot{y}}{\partial y} + \frac{\partial \dot{z}}{\partial z} + \frac{\partial \dot{w}}{\partial w} = -a - a + c = -7.4 \tag{6}$$

Hence,

$$dV(t) = V(0)e^{-7.4t} \tag{7}$$

So the new system (1) is dissipative and its volume shrinks to zero at $t \rightarrow \infty$ with an exponential rate of (-7.4) . Therefore, all system (1) orbits are ultimately confined to a specific subset of zero volume, and the asymptotic motion settles onto an attractor.

3.2 Equilibrium Points and Stability

In order to find the equilibrium points of the new 4-D hyperchaotic system (1) we should solving the following algebraic equations:

$$\begin{cases} -ax + y(1+z) = 0 \\ x - ay + bxz = 0 \\ cz - bxy + w = 0 \\ -dz = 0 \end{cases} \quad (8)$$

We take the parameters values as in (2), it is easy to check that the system of equations (8) has one equilibrium point:

$$S = [0, 0, 0, 0] \quad (9)$$

The stability of the equilibrium point S is discussed by linearizing system (1) at S using the following Jacobian matrix:

$$J_{x,y,z,w} = \begin{bmatrix} -a & 1+z & y & 0 \\ 1+bz & -a & bx & 0 \\ -by & -bx & c & 1 \\ 0 & 0 & -d & 0 \end{bmatrix} \quad (10)$$

For the equilibrium point S (9), the Jacobian matrix become as follows:

$$J_S = \begin{bmatrix} -a & 1 & 0 & 0 \\ 1 & -a & 0 & 0 \\ 0 & 0 & c & 1 \\ 0 & 0 & -d & 0 \end{bmatrix} \quad (11)$$

The corresponding characteristic equation is the following:

$$|J_S - \lambda I| = 0 \quad (12)$$

In order to find the eigenvalues of the Jacobian matrix (11), the parameters values as in (2) is considered. We are solving the corresponding characteristic equation (12) and the following characteristic polynomial of J_S is obtained:

$$\lambda^4 + 7.4\lambda^3 + 10.3\lambda^2 - 8.2\lambda + 1.5 \quad (13)$$

Then, the characteristic polynomial has the following roots:

$$\lambda_1 = -5, \lambda_2 = -3, \lambda_{3,4} = 0.3 \pm 0.1i \quad (14)$$

From (14) we note that exist two roots with positive real part, this shows that the equilibrium point S is unstable which implies chaos in the dissipative systems.

3.3 Lyapunov Exponents Spectrum and Bifurcation Analysis

Lyapunov exponents spectrum and bifurcation diagram represent the two most important tools to analyse the dynamical behaviour of the system. As it is known, the Lyapunov exponent is a measure of exponential rates of convergence and divergence for an uncertainty on the trajectories initial points. When it is positive the uncertainty increases, which means divergence of trajectories. So, the complexity of the dynamical behaviour increases with the increases in the number of positive Lyapunov exponents.

In this subsection, dynamical properties of the new 4-D system (1) are discussed with the control parameter d varying.

Fix $a=4$, $b=0.5$, $c=0$, and vary d

When the parameters a , b and c are fixed, while parameter $d \in [0,1]$ is varied, The bifurcation diagram and the Lyapunov exponents spectrum of system (1) are depicted in Figure 4 and Figure 5 respectively. We can see that the bifurcation diagram and the spectrum of the Lyapunov exponents are completely compatible.

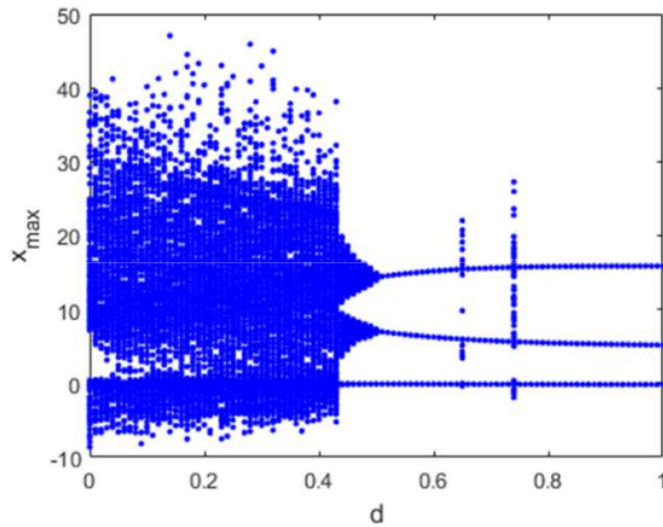

Figure 4 Bifurcation diagram of system (1) first state versus parameter d

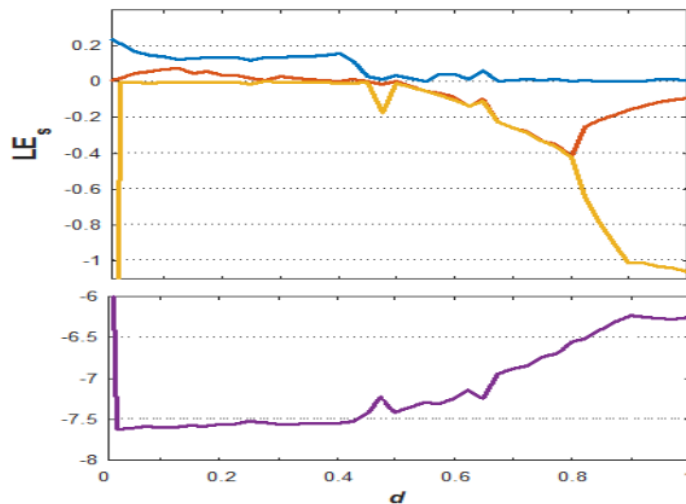

Figure 5 Lyapunov exponents of the system (1) versus parameter d

From Figure 4 and Figure 5, we note that the new system can exhibit different dynamical behaviours with the variation of the control parameter d . system (1) can exhibit periodic behaviour, quasi-periodic behaviour, chaotic behaviour with four-scroll attractor and hyperchaotic behaviour with four-scroll attractor.

When $d \in [0.55, 1]$ and $d \neq \{0.65, 0.74\}$, the new 4-D system (1) exhibits a periodic behaviour with one zero and three negatives Lyapunov exponents as depicted in Figure 6. When $d \in [0.46, 0.55]$, system (1) involves into a quasi-periodic attractor as shown in Figure 7 with two zero and two negatives Lyapunov exponents. When $d \in [0.37, 0.45]$ and $d = \{0.65, 0.74\}$, the proposed system (1) generates a chaotic behaviour with one positive Lyapunov exponents and four-scroll attractor as depicted in Figure 8. When $d \in [0.1, 0.36]$, the new proposed system (1) generate a hyperchaotic signals with two positive Lyapunov exponents and four-scroll attractor as shown in Figure 9.

In Table 1, Lyapunov exponents, Kaplan-Yorke dimension and dynamics of the new 4-D system for different values of d are given.

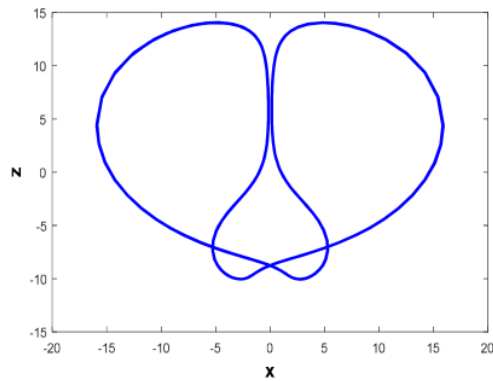

Figure 6 Phase portraits of the periodic orbits when $d=0.9$

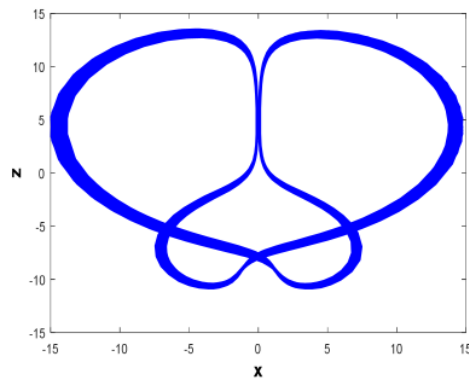

Figure 7 Phase portraits of the quasi-periodic orbits when $d=0.5$

Table 1 Lyapunov exponents, Kaplan-Yorke dimension and dynamics of system (1) with parameter d varying

d	LE_1	LE_2	LE_3	LE_4	D_{KY}	Dynamics	Figure
0.9	0	-0.160	-1.010	-6.231	0	Periodic	6
0.5	0	0	0	-7.401	0	Quasi-periodic	7
0.45	0.029	0	0	-7.431	3.004	Chaos	8
0.15	0.132	0.043	0	-7.573	3.023	Hyperchaos	9

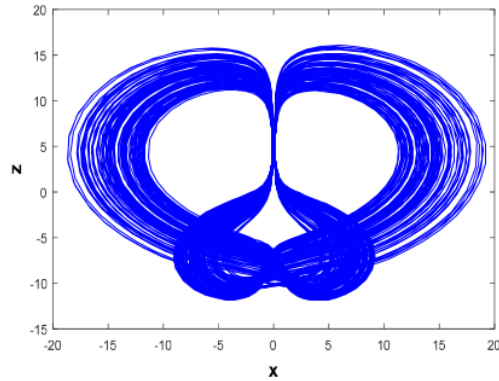

Figure 8 Phase portraits of the four-scroll chaotic attractor when $d=0.45$

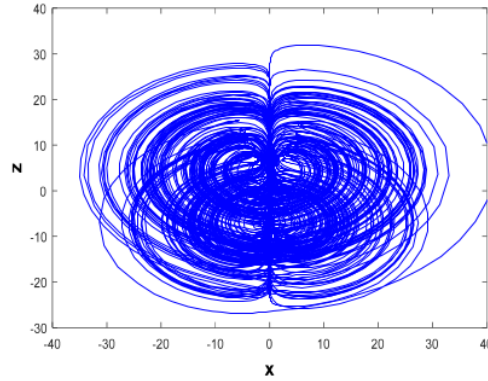

Figure 9 Phase portraits of the four-scroll hyperchaotic attractor when $d=0.15$

4. Electronic Circuit

In this section, an electronic circuit is designed using Multisim software to prove the feasibility of the proposed hyperchaotic system (1). The electronic circuit schematic of the new system (1) is shown in Figure 10.

By applying Kirchhoff's laws to the circuit in Figure 10, the corresponding circuit equations of the 4-D system (1) are given as follows:

$$\begin{cases} \dot{x} = -\frac{1}{R_1 C_1} x + \frac{1}{R_2 C_1} y + \frac{1}{R_3 C_1} yz \\ \dot{y} = \frac{1}{R_4 C_2} x - \frac{1}{R_5 C_2} y + \frac{1}{R_6 C_2} xz \\ \dot{z} = \frac{1}{R_7 C_3} z - \frac{1}{R_8 C_3} xy + \frac{1}{R_9 C_3} w \\ \dot{w} = -\frac{1}{R_{10} C_4} z \end{cases} \quad (15)$$

The values of the electronic circuit elements are chosen as follows:

$$\begin{cases} R_1 = R_5 = 100k \Omega \\ R_2 = R_3 = R_4 = R_9 = 400k \Omega \\ R_6 = R_8 = 800k \Omega \\ R_7 = 666.67k \Omega \\ R_{10} = 4M \Omega \\ \sum_{j=11}^{18} R_j = 100k \Omega \\ C_1 = C_2 = C_3 = C_4 = 1nF \end{cases} \quad (16)$$

Figure 11, Figure 12, Figure 13 and Figure 14 show respectively the periodic attractor, the quasi-periodic attractor, the four-scroll chaotic attractor and the four-scroll hyperchaotic attractor of the new system (1) generated by the circuit in Figure 10 and obtained using Multisim software.

We can see that Multisim results depicted in Figure 11, Figure 12, Figure 13 and Figure 14 are well consistent respectively with the Matlab simulation results shown in Figure 6, Figure 7, Figure 8 and Figure 9. Hence, the physical feasibility of the proposed system (1) is verified.

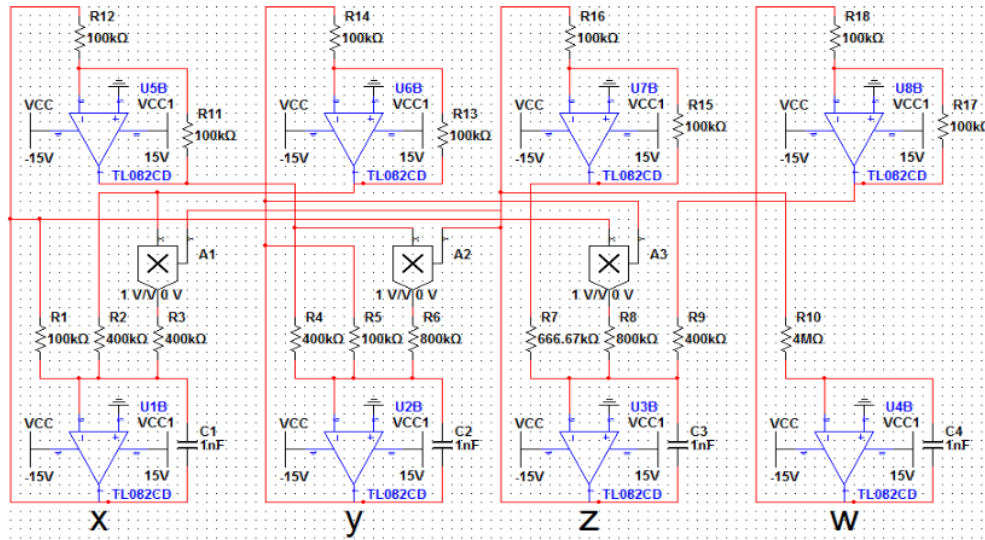

Figure 10 The circuit schematic of the new hyperchaotic system (1)

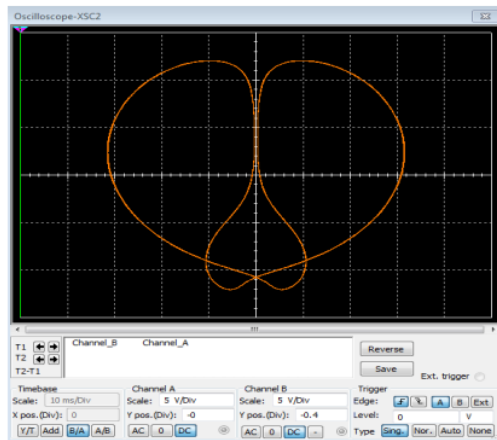

Figure 11 Multisim result of the x-z periodic orbit

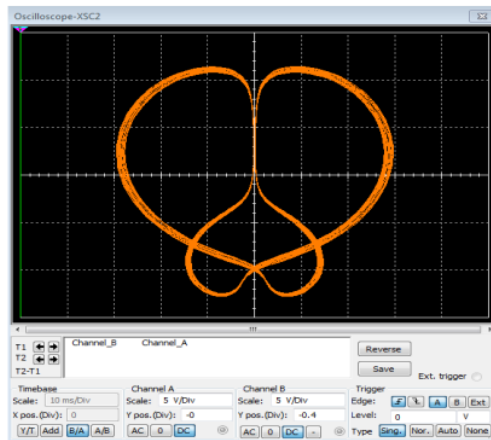

Figure 12 Multisim result of the x-z quasi-periodic orbit

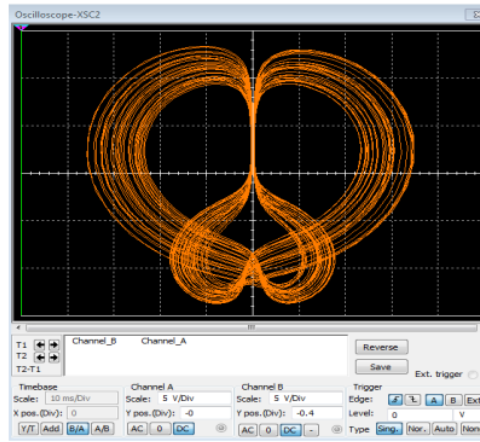

Figure 13 Multisim result of the x - z four-scroll chaotic attractor

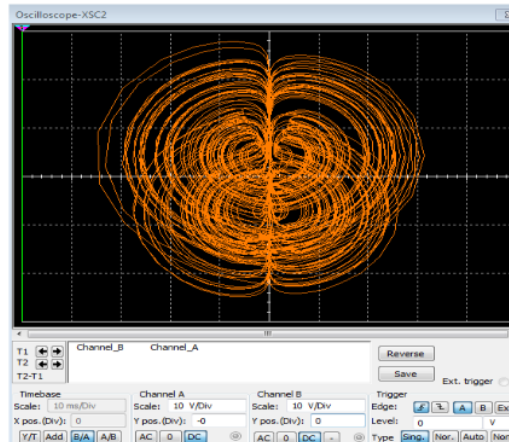

Figure 14 Multisim result of the x - z four-scroll hyperchaotic attractor

5. Conclusions

In this work, a new four-dimensional hyperchaotic system with one equilibrium point and three quadratic nonlinearities is first constructed. This system has rich dynamical behaviours, it can exhibit hyperchaotic behaviour with four-scroll attractor, chaotic behaviour with four-scroll attractor, quasi-periodic behaviour and periodic behaviour. Basic properties of the proposed model are studied by means of equilibrium points, phase portraits, Lyapunov exponents, Kaplan-Yorke dimension, and bifurcation diagrams. Then, the feasibility of the new hyperchaotic system is confirmed by designing its electronic circuit using Multisim software. We strongly believe that the very complex dynamical behaviour of this new 4-D four-scroll hyperchaotic system is desirable to use for many engineering applications in the near future.

References

- [1] Lorenz E N 1963 *J. Atmos. Sci* **20** 130
- [2] Benkouider K, Halimi M and Bouden T 2019 *Int. J. Comput. Appl. Technol* **60** 175-182
- [3] Sambas A, Vaidyanathan S, Zhang S, Zeng Y, Mohamed M A and Mamat M 2019 *IEEE Access* **7** 115454-115462
- [4] Sambas A, Vaidyanathan S, Tlelo-Cuautle E, Zhang S, Guillen-Fernandez O, Sukono, Hidayat Y and Gundara G 2019 *Electronics* **8** 1211
- [5] Liu P, Xi R, Ren P, Hou J and Li X 2018 *Complexity* **2018** 1–15
- [6] Vaidyanathan S, Sambas A, Kacar S and Cavusoglu U 2019 *Nonlinear Engineering* **8** 193-205
- [7] Akgul A, Hussain S and Pehlivan I 2016 *Optik* **127** 7062-7071
- [8] Çiçek S, Ferikoğlu A and Pehlivan I 2016 *Optik* **127** 4024-4030
- [9] Yang Q and Qiao X 2019 *International Journal of Bifurcation and Chaos* **29** 1950060
- [10] Benkouider K, Bouden T and Halimi M 2019 In *2019 4th world conference on complex systems* 1-6.
- [11] Zhang L 2017 *Optik* **131** 215–220

- [12] Benkouider K, Bouden T and Halimi M 2019 In *2019 6th international conference on control, decision and information technologies* 1717-1722
- [13] Jia Q 2007 *Phys. Lett. A* **366** 217–222
- [14] Matouk A E 2019 *International Journal of Dynamics and Control* **7** 241-255
- [15] Al-Khedhairi A, Elsonbaty A, Abdel Kader A H and Elsadany A A 2019 *Mathematical Problems in Engineering* **2019** 1-17
- [16] Rossler O E 1979 *Physics Letters A* **71** 155-157

ORIGINALITY REPORT

18%

SIMILARITY INDEX

8%

INTERNET SOURCES

16%

PUBLICATIONS

2%

STUDENT PAPERS

MATCH ALL SOURCES (ONLY SELECTED SOURCE PRINTED)

1%

★ Vicente, Raul, Jose L. Dauden, Pere Colet, Raul Toral, Hiroshi Amano, and Peter Blood. "", Physics and Simulation of Optoelectronic Devices XI, 2003.

Publication

Exclude quotes Off

Exclude matches Off

Exclude bibliography On

GRADEMARK REPORT

FINAL GRADE

/0

GENERAL COMMENTS

Instructor

PAGE 1

PAGE 2

PAGE 3

PAGE 4

PAGE 5

PAGE 6

PAGE 7

PAGE 8

PAGE 9

PAGE 10

PAGE 11

PAGE 12